

**Kol. Opis**1 **KPC 600 A**

Paznja! Slika proizvoda se može razlikovati od stvarnog proizvoda

Proizvodni broj: [98864015](#)

The KPC 300 and 600 are designed mainly for automatically operated, permanent domestic applications for draining basements and garages, which are subject to flooding.

Thanks to its compact, easy-to-handle design, it can also be used as a portable pump for emergencies such as lifting water from tanks or rivers, emptying swimming pools, fountains, excavations and underpasses.

It is also ideal for gardening and hobbies in general.

The level switch allows permanent installation and guarantees automatic pump operation.

**Tečnost:**

Dizana tečnost: bilo koja viskozna tečnost

Raspon temperature tečnosti: 273 .. 308 K

Gustina: 998.2 kg/m<sup>3</sup>

**Tehnički:**

Maksimalna veličina čestica: 10 mm

**Materijali:**

Kućište pumpe: NORYL GFN2

Rotor: NORYL GFN2

**Ugradnja:**

Izlaz pumpe: Rp 1 1/4

Maksimalna dubina instaliranja: 7 m

**Elektro podaci:**

Potrebna snaga - P1: 800 W

Frekvencija struje: 50 Hz

Potrebni napon: 1 x 220-240 V

Nazivna struja: 3.4 A

Veličina kondenzatora - radni: 14 µF/450 V

Klasa zaštite (IEC 34-5): IP68

Klasa izolacije (IEC 85): F

Dužina kablova: 10 m

Tip kablovskog utikača: SCHUKO

**Ostali:**

Neto masa: 6.5 kg

Bruto masa: 7 kg

Transportna zapremina: 0.021 m<sup>3</sup>

Country of origin: HU

Custom tariff no.: 84137021

## 98864015 KPC 600 A 50 Hz

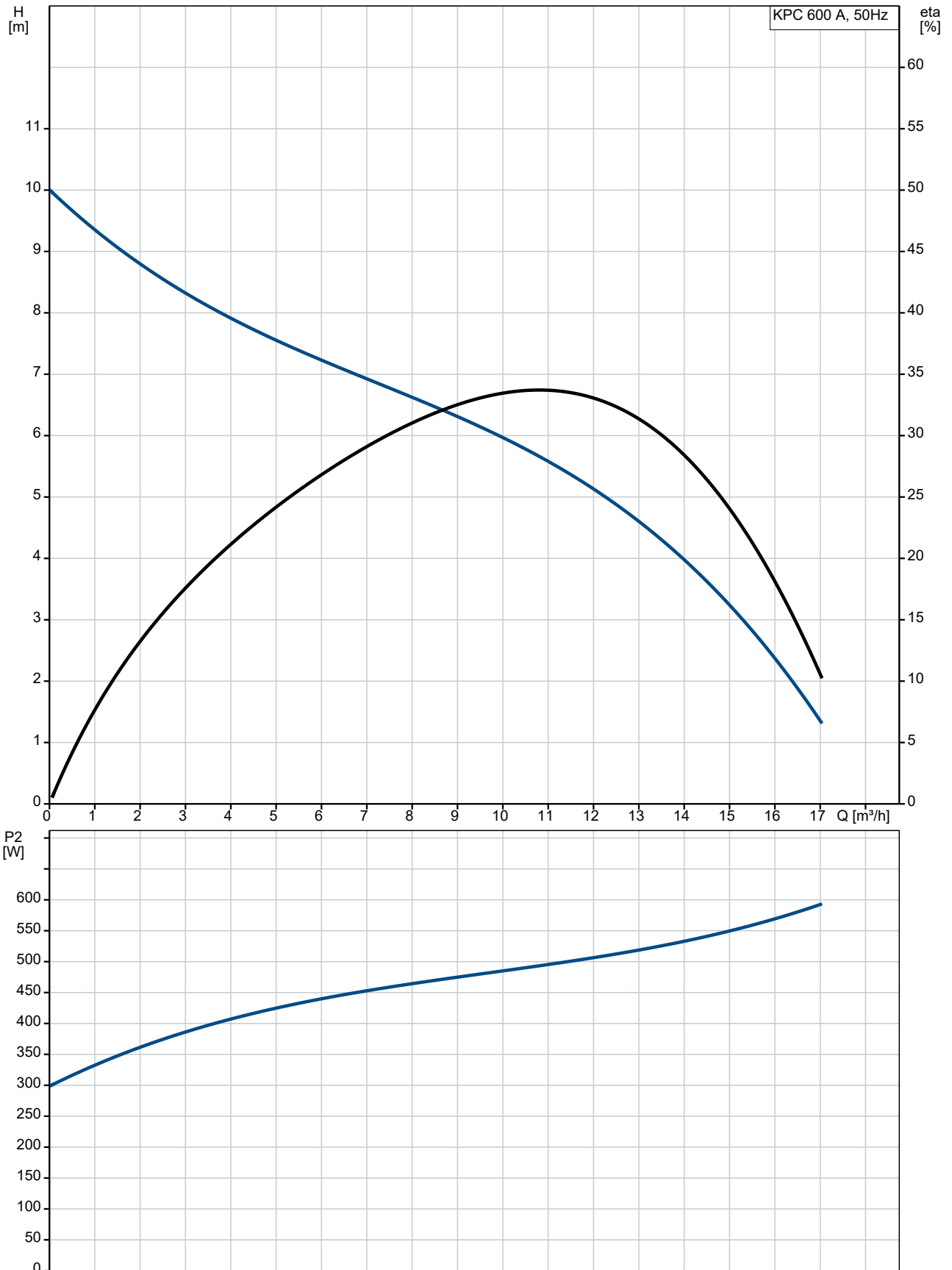

Opis	Vrednost
<b>Opšte informacije:</b>	
Ime proizvoda::	KPC 600 A
Šifra proizvoda:	98864015
EAN broj::	5712602588187
Cena:	€ 194.83
<b>Tehnički:</b>	
Maximum flow:	16 m <sup>3</sup> /h
Max. protok:	16 m <sup>3</sup> /h
Visina max.:	10.5 m
Maksimalna veličina čestica:	10 mm
Model:	A
<b>Materijali:</b>	
Kućište pumpe:	NORYL GFN2
Rotor:	NORYL GFN2
<b>Ugradnja:</b>	
Izlaz pumpe:	Rp 1 1/4
Maksimalna dubina instaliranja:	7 m
<b>Tečnost:</b>	
Dizana tečnost:	bilo koja viskozna tečnost
Raspon temperature tečnosti:	273 .. 308 K
Gustina:	998.2 kg/m <sup>3</sup>
<b>Elektro podaci:</b>	
Potrebna snaga - P1:	800 W
Frekvencija struje:	50 Hz
Potrebni napon:	1 x 220-240 V
Nazivna struja:	3.4 A
Veličina kondenzatora - radni:	14 µF/450 V
Klasa zaštite (IEC 34-5):	IP68
Klasa izolacije (IEC 85):	F
Termička zaštita:	interni
Dužina kabla:	10 m
Tip kablovskog utikača:	SCHUKO
<b>Kontrole:</b>	
Sklopka nivoa:	A/WITH
<b>Ostali:</b>	
Neto masa:	6.5 kg
Bruto masa:	7 kg
Transportna zapremina:	0.021 m <sup>3</sup>
Country of origin:	HU
Custom tariff no.:	84137021

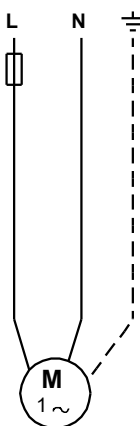
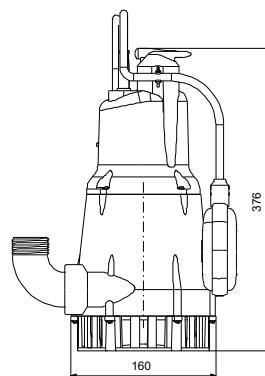
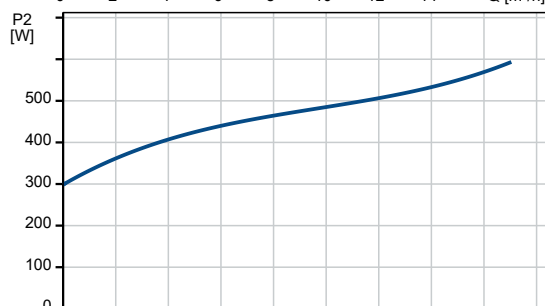
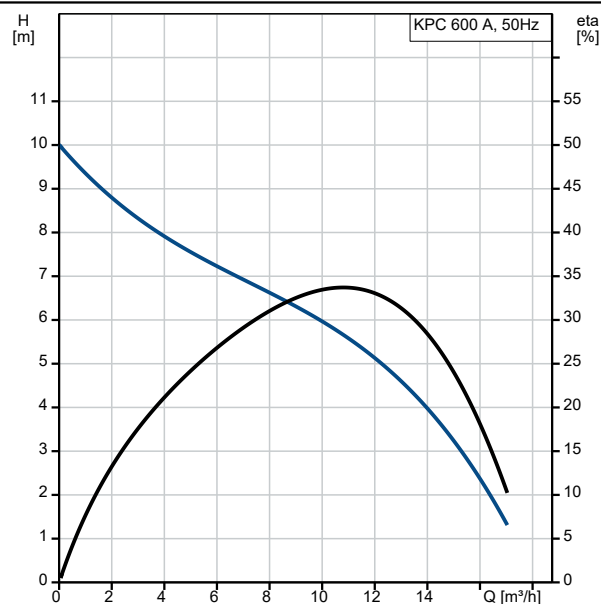

## 98864015 KPC 600 A 50 Hz

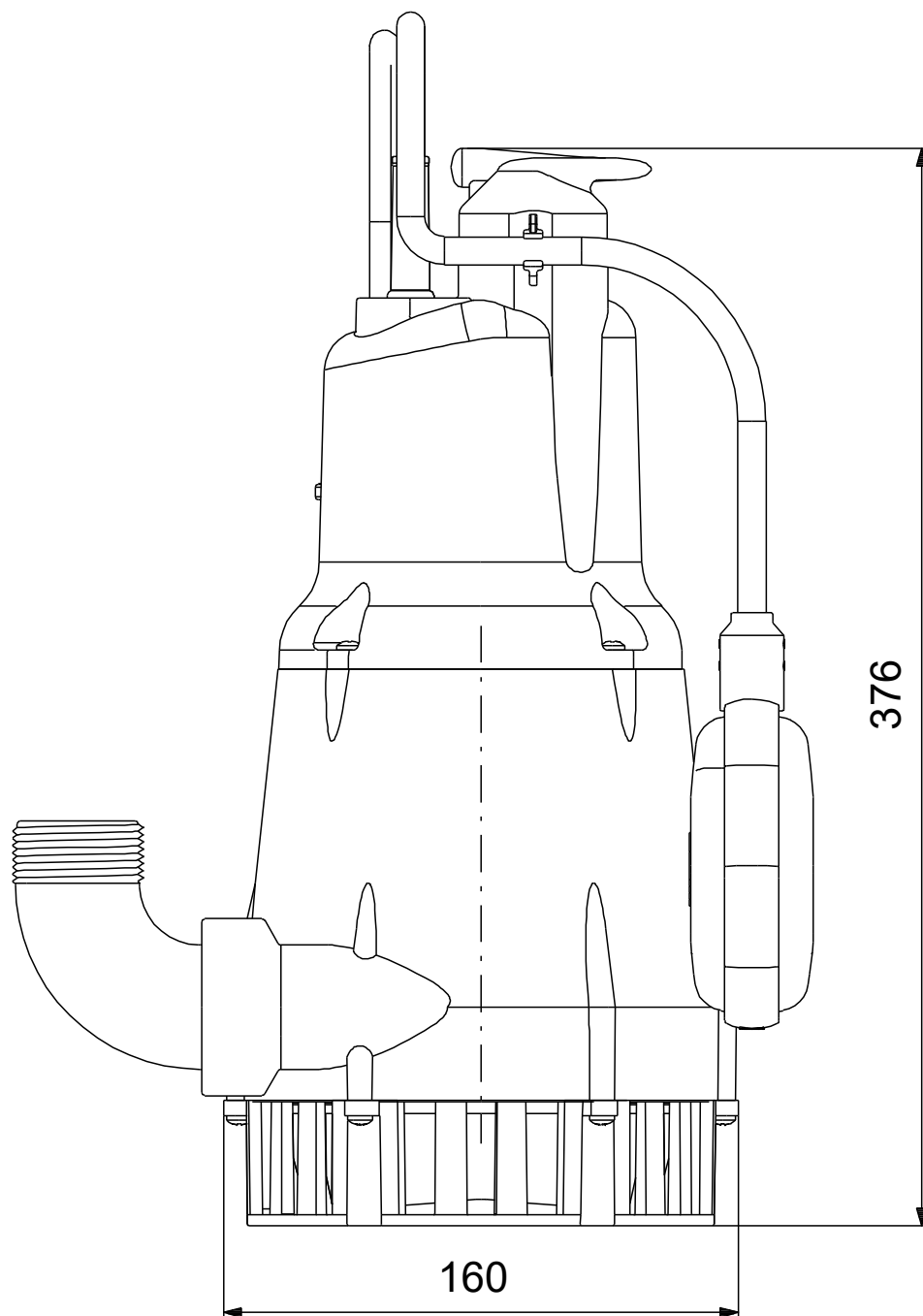

Napomena! Sve jedinice su u [mm] ukoliko drugačije nije navedeno.  
Upozorenje: Ovaj pojednostavljeni dimenzioni crtež ne pokazuje sve detalje.

98864015 KPC 600 A 50 Hz

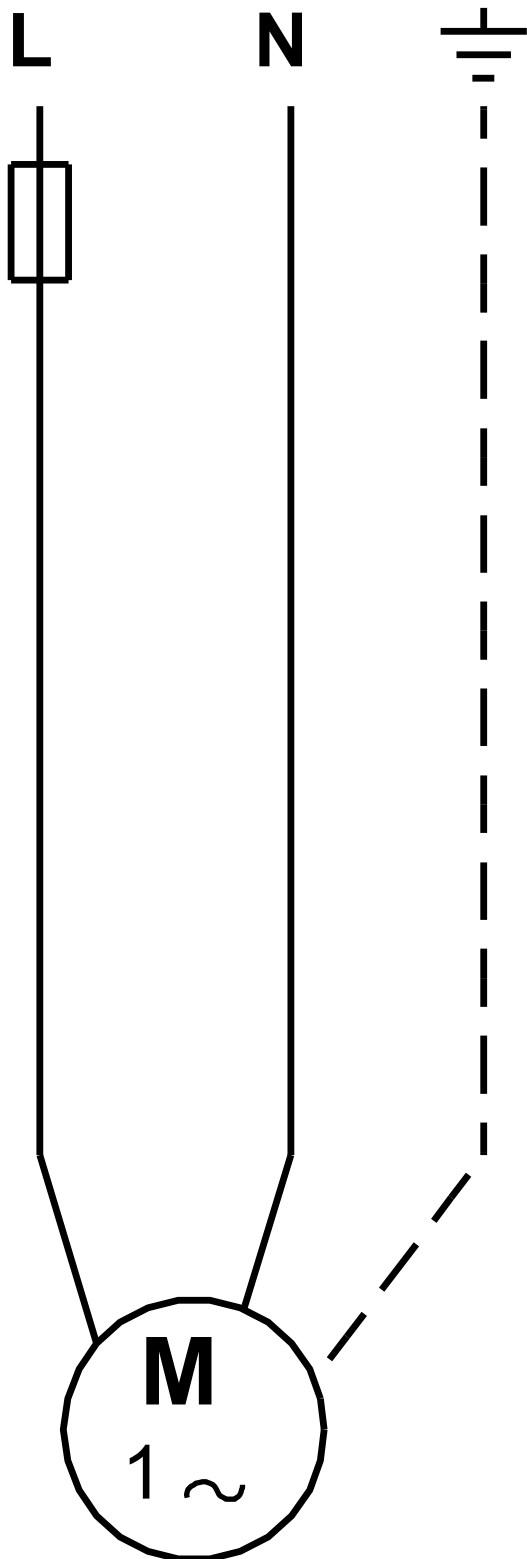

Pažnja! Sve jedinice su u [mm] ukoliko nije rečeno drugačije.